

Development of Smart and Portable Controllable Syringe Pump System for Medical Applications

Wael A. Salah^{1,*}, Basem Abu Zneid², Amir Abu_Al_Aish³ & Mays Nofal⁴

¹Department of Electrical Engineering, College of Engineering and Technology, Palestine Technical University – Kadoorie, P.O. Box: 7, Yafa Street, Tulkarm, Palestine

²Department of Electrical Engineering, College of Engineering (CE), University of Business and Technology (UBT) Jeddah 21448, Kingdom of Saudi Arabia

³Communication Engineering Department, Faculty of Engineering, Al-Hussein Bin Talal University, Ma'an, Jordan

⁴Central Tulkarm Laboratory, General Directorate of Paramedical Services, Ministry of Health, Palestine

Corresponding author: wael.salah@ptuk.edu.ps

Abstract

Due to their efficiency and adaptability, automated applications are consistently gaining popularity around the world. Robotics and their applications as used in a variety of commonplace industries, such as medical applications, require a high level of precision and accuracy. This can be achieved by utilizing automated applications. In this work, the development and design of a regulated injection pump is detailed. The developed prototype is a type of robot that can be utilized in hospitals and other medical facilities. The proposed design is used to pump specific liquid volumes as specified by the user. During liquid pumping, both the fluid's volume and velocity can be manipulated. Implementation of the proposed system required the development of a complete mechanical system and a controller. The proposed system was implemented successfully, and its operation was deemed satisfactory. According to the results, the accuracy of the system was also satisfactory. Using a flow sensor, the reference value and the measured value acquired from the designed device were compared. Compared to similar devices, the proposed system demonstrated exceptional precision, with an average error rate of less than 1.5%. The proposed model has the advantages of using a commercially available injection syringe and being significantly less expensive than similar devices on the market.

Keywords: *controllable; high precision; medical; microcontroller; portable; sensor; smart; syringe pump.*

Introduction

The issue of human health is a major concern for many members of society [1]. Numerous contemporary technologies can be used to protect human health. For example, pollutants in the indoor environment pose health risks to the occupants, so prediction of pollutant exposure is crucial for impact assessment and policy formulation concerning environmentally sustainable transportation [2]. New technologies and control systems are widely used in most types of applications to implement an effective and user-friendly design [3]. Flow systems obviously necessitate a fluid-driven system that must possess certain characteristics. Among them is the requirement that the flow must be as free of artifacts as possible, such as pulsations. Further, it would be desirable if the flow could be adjusted over a broad range, the fluid could be driven continuously, and the device could be programmed or synchronized to increase its applicability to various measurement protocols.

Flow analyzers typically employ two types of pumping systems: peristaltic pumps or syringe pumps. Peristaltic pumps comprise a rotor with a number of rollers that press a flexible tube, propelling the liquid inside through the rotor's rotation. They are able to continuously drive liquid from a reservoir, but the change from one roller to another causes a disturbing variation in flow, which can be recognized by a detector as noise. The flow can be modified by adjusting the inner diameter of the flexible tube and the rotational speed of the rotor [4]. Syringe pumps consist primarily of a syringe with a fixed volume, whose plunger is operated by a linear motor. The entire driven volume is limited to the volume put in the syringe, and the flow is practically noiseless. By adjusting the

syringe size and the motor speed it is possible to modify the flow. This type of pumps can be smaller and lighter, allowing them to be employed in medical applications to constantly dispense controlled medicine doses.

There are a number of manufacturers selling a wide range of syringe pumps, depending on the application and user needs. In addition, there are manual controlled versions, OEM, multichannel, programmable, micro-flow and high-pressure models. The prices of these devices normally vary within an average range from 250 to 5000 \$ and possibly more [4]. The syringe pump's structure is fairly straightforward and may be put together with little effort, some hand dexterity, and minimal material expenditure. When changing the flow, electronic motor control offers high levels of precision and accuracy. Micro-controlled operation also permits sequence programming and remote/centralized control. Due to the quick advancements in science and technology, using integrated embedded chips, microprocessors, and microcontrollers has become more advantageous [5,6].

Syringe pumps are useful for developing and testing microreactors as well as other microfluidic applications. In chemistry, these devices can be used to gently mix a predetermined amount of fluid into a solution. In enzyme kinetics, syringe pumps can be used as a component of a paused flow device to identify rapid kinetics. They are widely employed as lab media dispensers as well [7]. Historically, the oldest type of injection pump is the Graseby 3100, which was invented in 1998 by the British company SIMS Graseby Ltd. It has steps of 0.1 mL and a precision of $\pm 2\%$, featuring built-in software safety features, such as self-testing procedures for failure alarms that are loud and visible upon starting, wrongly positioned syringe detection, and automatic measurement of its size. It weighs 2.4 kg and may be operated by either a battery or mains power [8]. Syringe pumps have a wide range of applications, but they are mainly used in the medical industry. Other applications for these devices include chemical and biomedical research, palliative care, microfluidic applications, pumping sample/calibration into mass spectrometers, precise drug administration in animals, high pressure flow into reaction chambers, and factories for dyeing, paints, perfumes, and precision vehicles.

This article describes the design and implementation of an open-source syringe pump prototype. First, the design specifications are reviewed, then the hardware and software are explained, and finally the functionality of the pump is analyzed using measured test data. Samples of syringe pumps that are commercially available are provided. The proposed design aims to improve precision, increase operation speed, and reduce costs as the most essential performance goals. Implementation of the proposed robot design is superior to manual human operation for accomplishing these goals. The proposed device's design and construction were completed in three stages. First, the device's mechanical components were designed and developed. In addition to designing and testing the electronic components, the main programming of the microcontroller was also completed. And finally, the syringe pump system was completed by assembling the three components. Through visiting medical equipment technical support departments, a study was undertaken to investigate the use and effectiveness of comparable foreign devices in hospitals and ambulances in the city of Tulkarm, Palestine, summarizing their advantages and disadvantages. The results of this survey served as a guide for the design of a household appliance based on the findings of this study. The proposed device has a specific structure and design to be cost-effective at a reasonable price. The device's construction, components, formulas, and schematics as well as the circuit board production method are addressed in the subsequent sections. After that, the principal outcomes of our prototype are discussed and evaluated. The block diagram in Figure 1 shows the main functionality and the main flow of the proposed system's operation. It shows the mechanism of the device as well the input to output signal flow after passing it to the control panel.

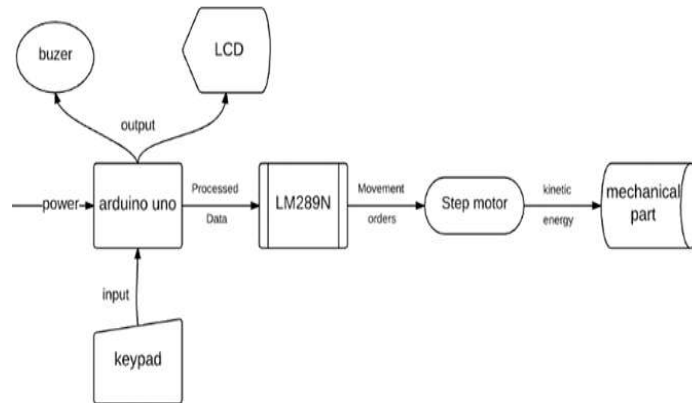

Figure 1 System block diagram.

The proposed design is superior to existing devices in a number of ways, but perhaps most crucially it can be easily produced at a low cost and will benefit research in small laboratories and hospitals that would otherwise be unable to afford it. Recently, this pump has been made open-source and is currently still fairly pricey.

Modeling, System Design and Implementation

In this section, the hardware of the proposed prototype is described in detail, along with its primary function. The hardware implementation consists of three main sections: mechanical, electrical, and programming. Each one is described and its function, installation, and calibration to obtain the optimal conditions for the project's objectives are elaborated on.

For the purposes of testing and validating the controller, the motor, LCD, keypad, and motor driver (LM298N) were simulated using Proteus. Additionally, the main program code for the controller was also simulated using Proteus, as shown in Figure 2.

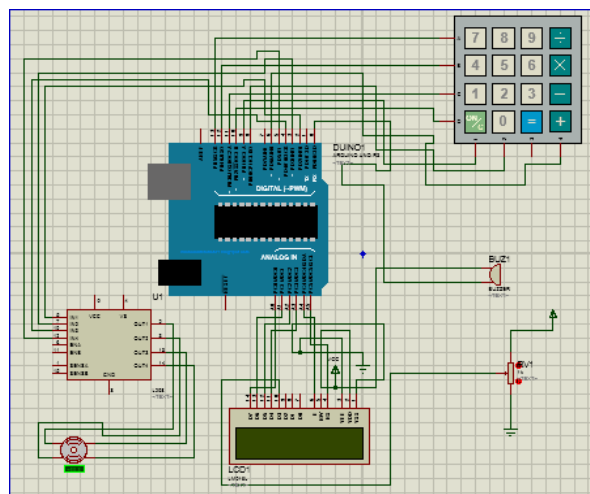

Figure 2 Proposed system circuit simulation.

Electronics Components

Stepper Motor

The torque required to move the syringe is provided by a stepper motor, as shown in Figure 3. The most common type of electrical motor, a DC motor, differs from a stepper motor in that the internal coil configuration separates the motor's revolution into steps. Most motor controllers are capable of micro stepping, which limits the motor's movement to small increments. The used stepper motor has fifty steps per revolution, with a five-second delay between each step.

Motor Driver (LM298N)

A driver is used to drive the syringe pump's stepper motor. The high-voltage, high-current twin full bridge driver (LM298) that was employed is shown in Figure 4. It is intended to power inductive loads, such as relays, solenoids, DC motors, and stepping motors. Moreover, it supports conventional TTL logic levels. Two enable inputs are provided to independently enable or disable the device regardless of the input signals. An equivalent external connector is used to connect an external sensing resistor to the linked emitters of each bridge's bottom transistor [9].



Figure 3 Stepper motor.

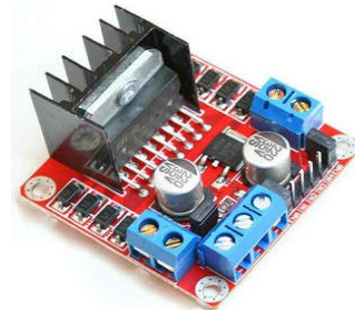

Figure 4 Motor driver (LM298N).

Arduino Uno

Arduino is an open-source electronics platform with user-friendly hardware and software, as depicted in Figure 5. Arduino boards can convert inputs to outputs to do things such as starting a motor, activating an LED, or uploading something online, including light from a sensor, a user's finger pressing a button, or a tweet. The board will be given instructions by sending its microcontroller a series of commands. This can be accomplished using the Processing-based Arduino software IDE and the Wiring-based Arduino Programming Language. The Arduino Uno microcontroller board contains six analog inputs, a 16 MHz quartz crystal, a USB connector, a power jack, an ICSP header, and a reset button. In addition, there are fourteen digital input/output pins, of which six are PWM outputs [10].

An Arduino Uno is used as the main controller and brain for the proposed device. It is utilized to control the movement of the syringe by reading the input from the keypad, translating it, and sending it to the LCD and the motor driver. Because it is easy to program and connect to a system, the Arduino microcontroller is recommended over its competitors. Additionally, it is less expensive than the others.

The Keypad

It is usually necessary to provide input to an Arduino system and in many cases a membrane-type keypad provides a practical and affordable alternative. They are thin enough to mount easily wherever they are needed [10]. In this case, the keypad is mostly employed to select the speed and size requirements as well as other general control requirements.

Liquid Crystal LCD

Figure 6 shows the LCD screen used to visualize interactive information and events. In addition, it provides information regarding the functionality of the device, such as speed and volume.



Figure 5 Arduino Uno.



Figure 6 Liquid crystal display (LCD).

Mechanical Components

Base Plate

The base plate is the major component of the syringe pump, as represented in Figure 7. In addition to supporting the mechanical loads, this 3D printed part is made to hold all the other components in place.

Trapezoidal Threaded Spindle

The motor's rotation is changed into a translational action with the aid of a spindle, as demonstrated in Figure 8. There are 93 teeth on this screw.

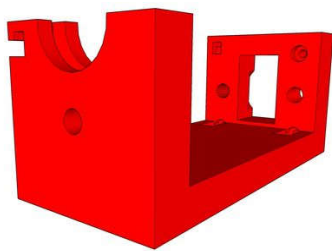

Figure 7 Base plate.



Figure 8 Trapezoidal threaded spindle.

Rods

The rods are made of iron and their function is to fix the pump parts together to ensure a lower error. The rods are shown as in Figure 9.

The Gears

The connector in Figure 10 is responsible for transferring the force from the motor to the spindle; the ratio of their respective tooth counts is 1/5.

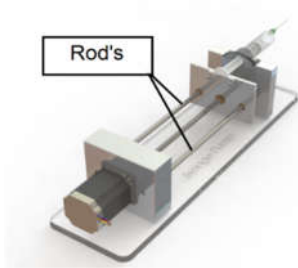

Figure 9 The rods.



Figure 10 The gears.

Syringe Carrier

A 3D-printed element with an indentation that grips the rear of the syringe's plunger and enables bidirectional movement is the syringe carrier depicted in Figure 11. This enables the syringe to be filled or emptied.

Cover

The cover is shown in Figure 12. This 3D-printed part is solely for aesthetic purposes and covers the motor compartment.

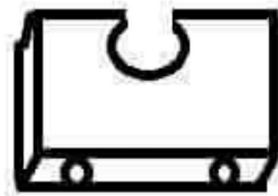

Figure 11 The syringe carrier.

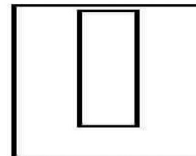

Figure 12 The cover.

Connector

A mechanical part is installed in the middle of the moving part widgets and joined with a screw in the process of converting the rotational movement to a linear movement. The connector is shown in Figure 13.

Widget Driving

The widget driving is a piece that shares a trapezoidal threaded spindle to convert the motor's movement from Dorian to linear and pushes the syringe only forward. Because of the installation of the syringe with a holder, the liquid is pushed out from the other side. The widget driving is shown in Figure 14.



Figure 13 The connector.

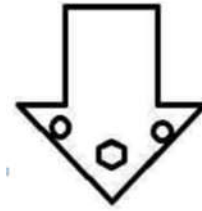

Figure 14 The widget driving.

10-ml Syringe

A 10-ml syringe with a Luer-Lok used is shown in Figure 15. All similarly sized syringes should work as well. The syringe serves as a container for bionic fluids. The mechanical components to be fully assembled to complete the mechanism that actuates the syringe pump are shown in Figure 16.



Figure 15 10-ml syringe.

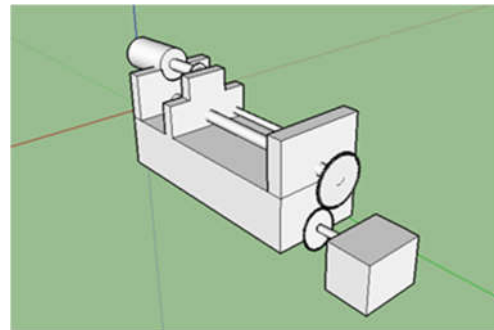

Figure 16 3D drawing of the device.

The complete system, which included mechanical and electrical parts, was successfully assembled as shown in Figure 17.

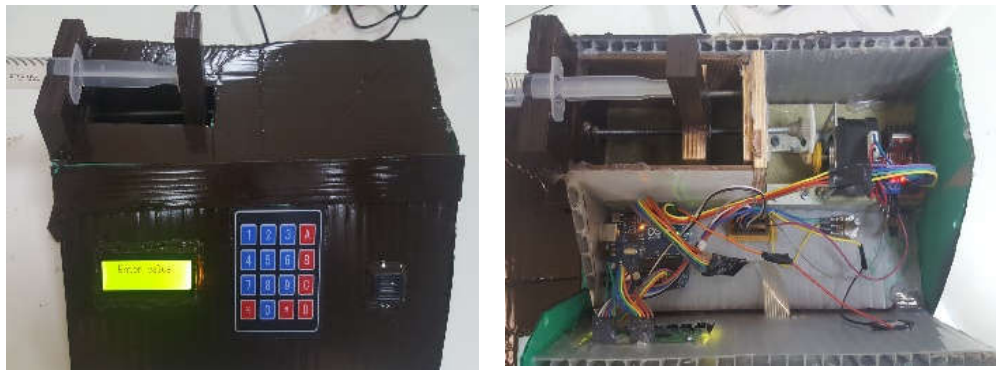

Figure 17 The complete implemented syringe pump.

Programming Section

The diagram shown in Figure 18 demonstrates the basic functionality of the developed device. The block chart illustrates the process' principal flow from the user's input of their preferred operation modes to the point at which the syringe is actually triggered.

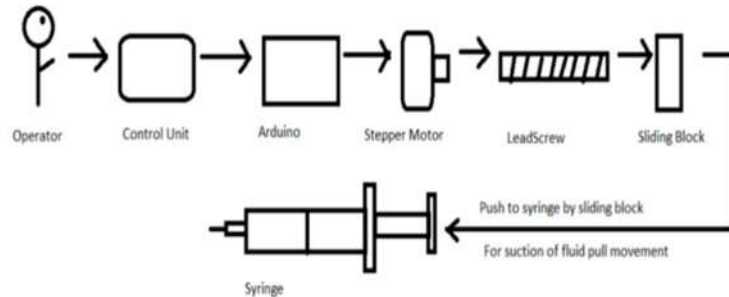

Figure 18 Machine operation mechanism.

The block diagram in Figure 19 describes how orders are transferred throughout the system's operation, including at the time an order is issued, while it is being executed, and after it has been completed. The process starts when the system is active, displays on the screen a request to the user to enter the appropriate size and speed via the keypad, and then processes these numbers.

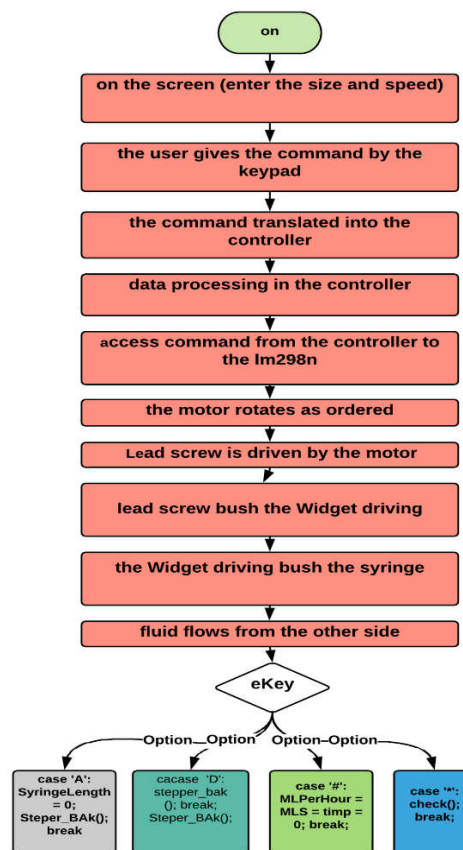

Figure 19 Machine operation mechanism.

These commands are transmitted to the controller, which then executes a series of equations and calculations. The instruction is given to the LM298N, which controls the motor, which in turn rotates the screw that drives the driver, which in turn drives the syringe.

There are several commands on the keypad that serve the purpose of control keys for the most part. These are the primary control buttons on the keypad:

- (#) Stops the process
- (*) Confirms the insertion of values
- (A) Returns the device to zero
- (D) Returns the device to the starting point

Results and Analysis

The system functions as follows: first, the proper syringe should be fixed to the device and filled with the proper medicine to be supplied to the patient. Then, some major commands given to the controller are processed through several equations and calculations to initialize the system. Based on these preferences, the controller generates the proper signal, which is sent to motor controller LM298N to control the motor accordingly. Thereafter, the motor drives the screw that drives the syringe accordingly.

In this section, the results of our practical experiments are presented. To validate the functionality of the proposed device, several test experiments were carried out. The test experiments mainly aimed to estimate the accuracy of the device and the relative error at different sizes and speeds. The outcome of these tests is summarized in the following graphs.

1. The first experiment was done with a fixed speed of 450 ml/h and the size was changed from 2 to 10 ml. The measured volume and the reference input volume were as shown in Figure 20.

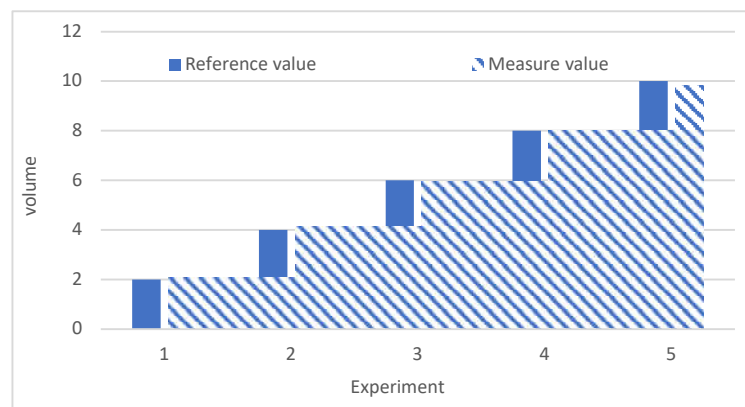

Figure 20 Measured error at 450 ml/h speed.

2. The second test experiment was carried out with a fixed speed of 250 ml/h and the size changed from 2 to 10 ml. The measured volume and the reference input volume are illustrated in Figure 21.

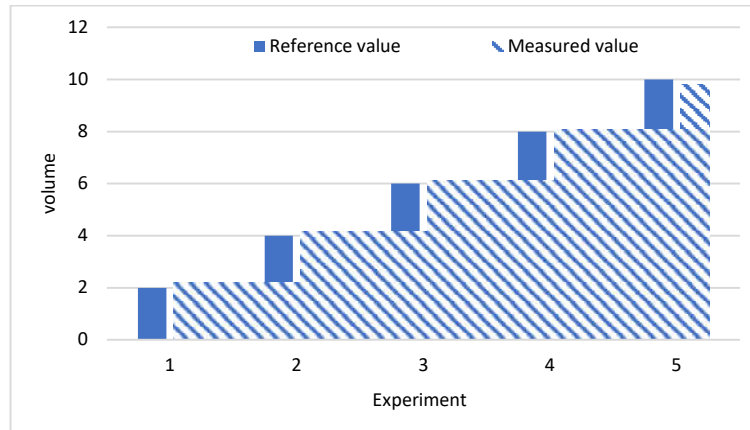

Figure 21 Measured error at 250 ml/h speed.

- In the third test, a fixed speed of 100 ml/h was used and the size changed from 2 to 10 ml. The measured volume and the reference input volume were as shown in Figure 22.

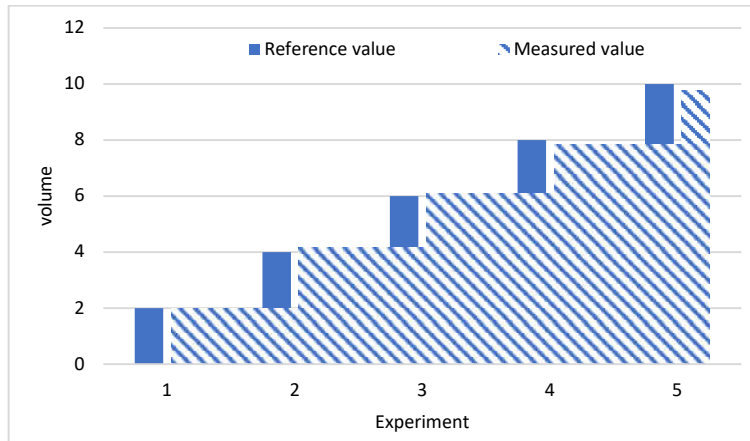

Figure 22 Measured error at of 100 ml/h speed.

Based on the results shown, the relative error ratio was estimated for each test experiment. The relative error percentage for each test in reference to volume is illustrated in Figure 23.

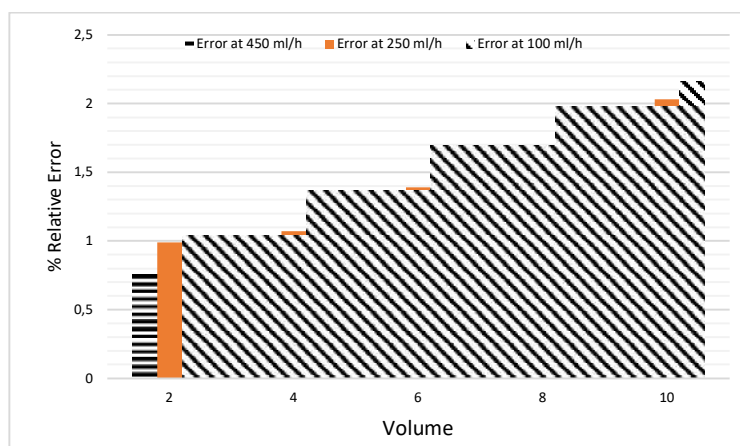

Figure 23 Error percentage with changes in volume and speed.

In view of the values shown in the results, it can be noted that the error rate of the device is proportional to the size of the required sample and is inversely proportional to the injection speed of the device.

In addition, the error percentage was small when tested with a size of 2 ml. As the size increased the error gradually increased. The value of the error at 4 ml increased and increased more at a volume of 6 ml upwards.

At the same size for three speeds, the percentage error in relation to the speed variation was found to be minimal when the speed was 450 ml/h, increased when the speed was 250 ml/h, and increased even more when the speed was 100 ml/h. The average error percentages for the three speeds are shown in Figure 24.

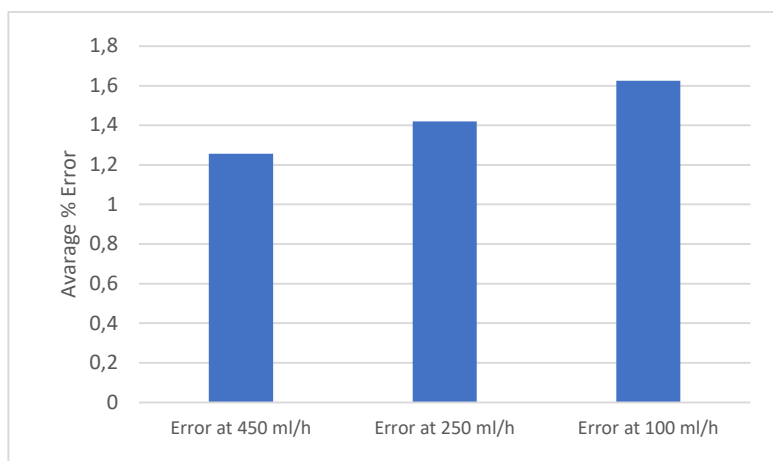

Figure 24 Average error percentages for the three speeds.

Analysis and Comparison

Table 1 displays the similarities and differences between the developed device and some market-available devices. These devices are primarily distinguished by their small size, light weight, portability, and adaptability to a variety of syringe sizes. Table 1 provides a detailed comparison of the key benefits of the deployed device.

Table 1 Comparison with similar devices in the market.

Comparison / device	®Infusomat® [12]	Orchestra® [11]	Proposed design
Dimensions (W x H x D) (mm)	214 x 68 x 124	315 x 105 x 130	80 x 100 x 300
Flexible syringe sizes	No	Yes	No
Speed control	Yes	3 ml/h, programmable	Yes
Error	±5 %	±5%	±1.5%
Weight	1.4 kg	2.4 kg	1.2 kg
Voltage (DC)	11-16 V	7-15 V	7 V
Battery Power	Yes	yes	No

A number of devices with comparable designs have been developed by a number of researchers. The following is a summary of some of these devices' primary properties and designs. A comparable prototype known as a single acting syringe pump was designed by K. Akash from the School of Mechanical Engineering at Sastra University. It was created with a stepper motor and a GPIO controller, and the size and speed of injection are what control it. The findings of the prototype's testing indicated that there was a rate of error equal to 3% [13].

Pedro Guimarães of the Polytechnic Institute of Porto produced an improved design. The device was constructed using a stepper motor and an Arduino controller. Additionally, Guimarães established a website for a feed presentation on the operation of the device that he evaluated while continuing to keep track of the injection processes. The results indicated that the tested experiment had an error rate of roughly 4% [14].

Additionally, the Czech Technical University in Prague created a unique syringe pump system design. This design also includes a step motor and an Arduino controller. The proposed design made the claim that it could alter the syringe's size. According to testing of the proposed design, this device had an error of around 6% [8].

Table 2 demonstrates that the proposed device has several advantages over devices recently developed by other researchers. The employment of an Arduino as the controller and the utilization of a stepper motor are the most prominent shared features. In contrast, the proposed device has the capacity to adjust the injection speed. In addition, the proposed design is distinguished from existing designs by its superior accuracy.

Table 2 Comparison with other developed devices.

Comparison / device	Controller type	Motor type	Speed Control	Flexible Syringe size	Web site	Error %
Purposed device	Arduino	stepper motor	Yes	No	No	±1.5%
K. Akash device [14]	Arduino	stepper motor	No	No	yes	±4%
Pedro Guimaraes device [8]	Arduino	stepper motor	No	yes	No	±6%
Adam Polak device [13]	GPIO	stepper motor	Yes	No	No	±3%

The implementation of the proposed design using a widely used controller enables it to be easily connected and combined with other devices [15], mainly with IoT enabled devices, which are widely used nowadays. Also, the possibility to design a smart phone mobile application could be an addition in future improvement of the device.

Conclusions

A syringe pump system was developed to provide an automated approach for controlling fluid flow. This paper highlighted and discussed its three-dimensional design, linear motion, electronics, and programming. The driving force that regulates the flow of fluid is provided by a stepper motor attached to a plunger by the rotation of a linear slider. The fluid control system can dispense fluid at speeds ranging from 5 ml/h to 450 ml/h with a low error rate. Implementation of the microfluidic bonding method is a basic and effective procedure for fabricating microfluidic devices. The relationship between the error rate, injection speed, and needed size was identified by the experimental findings. At high speeds, the proposed syringe pump system operated with high precision and an average error of less than 1.5 percent. The proposed syringe pump is substantially less expensive than similar devices on the market and utilizes an injectable syringe that is commercially available.

Acknowledgments

The authors like to express their gratitude to Palestine Technical University – Kadoorie (PTUK) for providing technical support and making this research possible. In addition, the authors would like to extend their gratitude to the undergraduate students who assisted with the lab work: Ali Alaswad, Anaam Awadi, Raghad Aanyora, Rami Tomah, and Oday Ghazal.

References

- [1] Salah, W.A., Albreem, M.A. & Zneid, B.A., *Implementation of Smart House Digital Applications for Safety and Health*, Journal of Engineering Science and Technology, **15**(4), pp. 2679-2695, August 2020.
- [2] Yudison, A.P., *Development of Indoor Air Pollution Concentration Prediction by Geospatial Analysis*, Journal of Engineering & Technological Sciences, **47**(3), pp. 306-319, July 2015.
- [3] Panjaitan, S.D. & Sitorus, B., *Formal Design and Analysis of a Wastewater Treatment Control System Based On Petri Net*, ITB J. Eng. Sci., **44**(1), pp. 1-20, April 2012. DOI: 10.5614/itbj.eng.sci.2012.44.1.1
- [4] Kujawa, M., Motąła, S., Gonet, M., Pietrzyk, R., Czechowski, T. & Baranowski, M., *Low-Cost, Programmable Infusion Pump with Bolus Mode for In-Vivo Imaging*, HardwareX, **9**, e00194, April 2021.
- [5] Salah, W.A. & Zneid, B.A., *Evolution of Microcontroller-Based Remote Monitoring System Applications*, International Journal of Electrical and Computer Engineering, **9**(4), pp. 2354-2363, 2019.
- [6] Salah, W.A., Albreem, M.A. & Zneid, B.A., *Implementation of Smart House Digital Applications for Safety and Health*, Journal of Engineering Science and Technology, **15**(4), pp. 2679-2695, March 2020.
- [7] Graseby, S.I.M.S., *Graseby 3100 Syringe Pump, Instruction Manual*, pp. 1-18, May 2017.
- [8] Polák, A., *Design and Fabrication of Controllable Syringe Pumps for Microfluidics*, Prague: Czech Technical University in Prague, Bachelor Project, pp. 1-39, May 2017.
- [9] Dual Full Bridge Driver L298 Datasheet, 2000.
- [10] Arduino LLC, Data sheet, 2015.
- [11] Orchestra® Syringe Pump Data Sheet, 2017.
- [12] Infusomat® Syringe Pump Data Sheet," 2017.
- [13] Akash, K., Kumar, M.P., Venkatesan, N. & Venkatesan, M., *A Single Acting Syringe Pump Based on Raspberry Pi-SOC*, IEEE 2015 International Conference on Computational Intelligence and Computing Research (ICIC), pp. 1-3, December 2015.
- [14] Assuncao, R., Barbosa, P., Ruge, R., Guimarães, P.S., Alves, J., Silva, I. & Marques, M. A., *Developing the Control System of a Syringe Infusion Pump*, The 11th International Conference on Remote Engineering and Virtual Instrumentation (REV), pp. 254-255, February 2014.
- [15] Albreem, M.A., El-Saleh, A.A., Isa, M., Salah, W., Jusoh, M., Azizan, M.M. & Ali, A., *Green Internet of Things (Iot): An Overview*, The 2017 IEEE 4th International Conference on Smart Instrumentation, Measurement and Application (ICSIMA), pp. 1-6, November 2017.